

TOTAL

One-Stop Tools Station

TOTAL

PRODUCT MANUAL

LITHIUM-ION ROTARY HAMMER

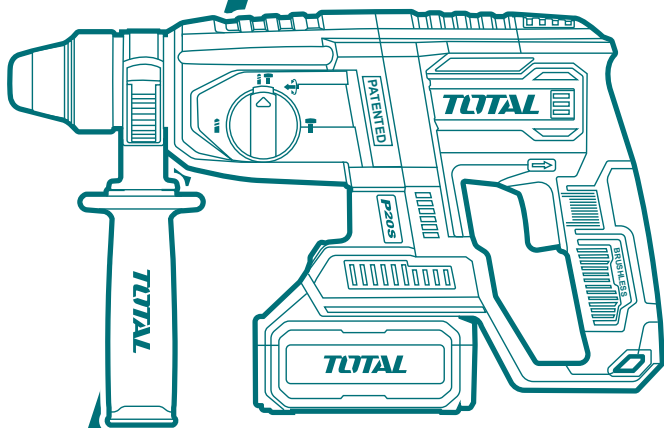

TRHLI20228 TRHLI2022875 TRHLI20228xy
UTRHLI20228 UTRHLI2022875 UTRHLI20228xy
x (blank, 1, 2, 3, 4, 5, 6, 7, 8, 9, E, S, A, M)
y (blank, -1, -2, -3, -4, -5, -6, -7, -8, -9, E, S, A, M)



GENERAL POWER TOOL SAFETY WARNINGS

⚠ WARNING Read all safety warnings, instructions, illustrations and specifications provided with this power tool. *Failure to follow all instructions listed below may result in electric shock, fire and/or serious injury.*

Save all warnings and instructions for future reference.

The term "power tool" in the warnings refers to your mains-operated (corded) power tool or battery-operated (cordless) power tool.

1) Work area safety

- a) **Keep work area clean and well lit.** *Cluttered or dark areas invite accidents.*
- b) **Do not operate power tools in explosive atmospheres, such as in the presence of flammable liquids, gases or dust.** *Power tools create sparks which may ignite the dust or fumes.*
- c) **Keep children and bystanders away while operating a power tool.** *Distractions can cause you to lose control.*

2) Electrical safety

- a) **Power tool plugs must match the outlet. Never modify the plug in any way. Do not use any adapter plugs with earthed (grounded) power tools.** *Unmodified plugs and matching outlets will reduce risk of electric shock.*
- b) **Avoid body contact with earthed or grounded surfaces, such as pipes, radiators, ranges and refrigerators.** *There is an increased risk of electric shock if your body is earthed or grounded.*
- c) **Do not expose power tools to rain or wet conditions.** *Water entering a power tool will increase the risk of electric shock.*
- d) **Do not abuse the cord. Never use the cord for carrying, pulling or unplugging the power tool. Keep cord away from heat, oil, sharp edges or moving parts.** *Damaged or entangled cords increase the risk of electric shock.*
- e) **When operating a power tool outdoors, use an extension cord suitable for outdoor use.** *Use of a cord suitable for outdoor use reduces the risk of electric shock.*
- f) **If operating a power tool in a damp location is unavoidable, use a residual current device (RCD) protected supply.** *Use of an RCD reduces the risk of electric shock.*

3) Personal safety

- a) **Stay alert, watch what you are doing and use common sense when operating a power tool. Do not use a power tool while you are tired or under the influence of drugs, alcohol or medication. A moment of inattention while operating power tools may result in serious personal injury.**
- b) **Use personal protective equipment. Always wear eye protection. Protective equipment such as a dust mask, non-skid safety shoes, hard hat or hearing protection used for appropriate conditions will reduce personal injuries.**
- c) **Prevent unintentional starting. Ensure the switch is in the off-position before connecting to power source and/or battery pack, picking up or carrying the tool. Carrying power tools with your finger on the switch or energising power tools that have the switch on invites accidents.**
- d) **Remove any adjusting key or wrench before turning the power tool on. A wrench or a key left attached to a rotating part of the power tool may result in personal injury.**
- e) **Do not overreach. Keep proper footing and balance at all times. This enables better control of the power tool in unexpected situations.**
- f) **Dress properly. Do not wear loose clothing or jewellery. Keep your hair and clothing away from moving parts. Loose clothes, jewellery or long hair can be caught in moving parts.**
- g) **If devices are provided for the connection of dust extraction and collection facilities, ensure these are connected and properly used. Use of dust collection can reduce dust-related hazards.**
- h) **Do not let familiarity gained from frequent use of tools allow you to become complacent and ignore tool safety principles. A careless action can cause severe injury within a fraction of a second.**

4) Power tool use and care

- a) **Do not force the power tool. Use the correct power tool for your application. The correct power tool will do the job better and safer at the rate for which it was designed.**
- b) **Do not use the power tool if the switch does not turn it on and off. Any power tool that cannot be controlled with the switch is dangerous and must be repaired.**
- c) **Disconnect the plug from the power source and/or remove the battery**

pack, if detachable, from the power tool before making any adjustments, changing accessories, or storing power tools. *Such preventive safety measures reduce the risk of starting the power tool accidentally.*

- d) **Store idle power tools out of the reach of children and do not allow persons unfamiliar with the power tool or these instructions to operate the power tool.** *Power tools are dangerous in the hands of untrained users.*
- e) **Maintain power tools and accessories. Check for misalignment or binding of moving parts, breakage of parts and any other condition that may affect the power tool's operation. If damaged, have the power tool repaired before use.** *Many accidents are caused by poorly maintained power tools.*
- f) **Keep cutting tools sharp and clean.** *Properly maintained cutting tools with sharp cutting edges are less likely to bind and are easier to control.*
- g) **Use the power tool, accessories and tool bits etc. in accordance with these instructions, taking into account the working conditions and the work to be performed.** *Use of the power tool for operations different from those intended could result in a hazardous situation.*
- h) **Keep handles and grasping surfaces dry, clean and free from oil and grease.** *Slippery handles and grasping surfaces do not allow for safe handling and control of the tool in unexpected situations.*

5) Battery tool use and care

- a) **Recharge only with the charger specified by the manufacturer.** *A charger that is suitable for one type of battery pack may create a risk of fire when used with another battery pack.*
- b) **Use power tools only with specifically designated battery packs.** *Use of any other battery packs may create a risk of injury and fire.*
- c) **When battery pack is not in use, keep it away from other metal objects, like paper clips, coins, keys, nails, screws or other small metal objects, that can make a connection from one terminal to another.** *Shorting the battery terminals together may cause burns or a fire.*
- d) **Under abusive conditions, liquid may be ejected from the battery; avoid contact. If contact accidentally occurs, flush with water. If liquid contacts eyes, additionally seek medical help.** *Liquid ejected from the battery may cause irritation or burns.*

- e) **Do not use a battery pack or tool that is damaged or modified.** *Damaged or modified batteries may exhibit unpredictable behaviour resulting in fire, explosion or risk of injury.*
- f) **Do not expose a battery pack or tool to fire or excessive temperature.** *Exposure to fire or temperature above 130 °C may cause explosion.*
- g) **Follow all charging instructions and do not charge the battery pack or tool outside the temperature range specified in the instructions.** *Charging improperly or at temperatures outside the specified range may damage the battery and increase the risk of fire.*

6) Service

- a) **Have your power tool serviced by a qualified repair person using only identical replacement parts.** *This will ensure that the safety of the power tool is maintained.*
- b) **Never service damaged battery packs.** *Service of battery packs should only be performed by the manufacturer or authorized service providers*

BATTERY TOOL SAFETY WARNINGS

Save these instructions.

⚠ CAUTION

Only use genuine original batteries. *Use of non-genuine batteries, or batteries that have been altered, may result in the battery bursting causing fires, personal injury, and damage. It will also void the warranty for the tool and charged and dark areas invite accidents.*

⚠ WARNING

- a) **Do not dismantle, open or shred secondary cells or batteries.**
- b) **Keep batteries out of the reach of children.** *Battery usage by children should be supervised. Especially keep small batteries out of reach of small children.*
- c) **Seek medical advice immediately if a cell or a battery has been swallowed.**
- d) **Do not expose cells or batteries to heat or fire.** *Avoid storage in direct sunlight.*
- e) **Do not short-circuit a cell or a battery.** *Do not store cells or batteries haphazardly in a box or drawer where they may short-circuit each other or be short-circuited by other metal objects.*
- f) **Do not remove a cell or battery from its original packaging until required for use.**
- g) **Do not subject cells or batteries to mechanical shock.**
- h) **In the event of a cell leaking, do not allow the liquid to come in contact with the skin or eyes.** *If contact has been made, wash the affected area with copious amounts of water and seek medical advice.*
- i) **Do not use any charger other than that specifically provided for use with the equipment.**
- j) **Observe the plus (+) and minus (-) marks on the cell, battery and equipment and ensure correct use.**
- k) **Do not use any cell or battery which is not designed for use with the equipment.**
- l) **Do not mix cells of different manufacture, capacity, size or type within a device.**
- m) **Always purchase the battery recommended by the device manufacturer for the equipment.**
- n) **Keep cells and batteries clean and dry.**
- o) **Wipe the cell or battery terminals with a clean dry cloth if they become**

dirty.

- p) Secondary cells and batteries need to be charged before use.** *Always use the correct charger and refer to the manufacturer's instructions or equipment manual for proper charging instructions.*
- q) Do not leave a battery on prolonged charge when not in use.**
- r) After extended periods of storage, it may be necessary to charge and discharge the cells or batteries times to obtain maximum performance.**
- s) Retain the original product literature for future reference.**
- t) Use the cell or battery only in the application for which it was intended.**
- u) When possible, remove the battery from the equipment when not in use.**
- v) Dispose of properly.**

Tips for maintaining maximum battery life

- a) Charge the battery cartridge before completely discharged.** *Always stop tool operation and charge the battery cartridge when you notice less tool power.*
- b) Never recharge a fully charged battery cartridge.** *Overcharging shortens the battery service life.*
- c) Charge the battery cartridge with room temperature at 10°C-40°C (50°F-104°F).** *Let a hot battery cartridge cool down before charging it.*
- d) Charge the battery cartridge if you do not use it for a long period (more than six months).**

Important safety instructions for battery cartridge

- 1. Before using battery cartridge, read all instructions and cautionary markings on battery charger, battery, and) product using battery.**
- 2. Do not disassemble battery cartridge.**
- 3. If operating time has become excessively shorter, stop operating immediately.** *It may result in a risk of overheating, possible burns and even an explosion.*
- 4. If electrolyte gets into your eyes, rinse them out with clear water and seek medical attention right away.** *It may result in loss of your eyesight.*
- 5. Do not short the battery cartridge:**
 - a) Do not touch the terminals with any conductive material.**
 - b) Avoid storing battery cartridge in a container with other metal objects such as nails, coins, etc.**

- c) *Do not expose battery cartridge to water or rain.*
 - d) *A battery short can cause a large current flow, overheating, possible burns and even a breakdown.*
6. **Do not store the tool and battery cartridge in locations where the temperature may reach or exceed 50°C (122°F).**
 7. **Do not incinerate the battery cartridge even if it is severely damaged or is completely worn out. *The battery cartridge can explode in a fire.***
 8. **Be careful not to drop or strike battery.**
 9. **Do not use a damaged battery.**
 10. **Follow your local regulations relating to disposal of battery.**

Tool / battery protection system

The tool is equipped with a tool/battery protection system. This system automatically cuts off power to the motor to extend tool and battery life. The tool will automatically stop during operation if the tool or battery is placed under one of the following conditions:

Overload protection

When the battery is operated in a manner that causes it to draw an abnormally high current, the tool automatically stops without any indication. In this situation, turn the tool off and stop the application that caused the tool to become overloaded. Then turn the tool on to restart.

Overheat protection

When the tool/battery is overheated, the tool stops automatically. In this situation, let the tool/battery cool before turning the tool on again.

Transportation

Batteries comply with all applicable shipping regulations as prescribed by industry and legal standards (for more information, check with the manufacturer).

Transporting batteries can possibly cause fire if the battery terminals inadvertently come in contact with conductive materials. When transporting batteries, make sure that the battery terminals are protected and well insulated from materials that could contact them and cause a short circuit.

The information provided in this section of the manual is provided in good faith and believed to be accurate at the time the document was created. However, no warranty, expressed or implied, is given. It is the buyer's responsibility to ensure

that its activities comply with the applicable regulations.

Protecting the environment

Separate collection. This product must not be disposed of with normal household waste.

Should you find one day that your product needs replacement, or if it is of no further use to you, do not dispose of it with household waste. Make this product available for separate collection.

Separate collection of used products and packaging allows materials to be recycled and used again. Re-use of recycled materials helps prevent environmental pollution and reduces the demand for raw materials.











Local regulations may provide for separate collection of electrical products from the household, at municipal waste sites or by the retailer when you purchase a new product.

Rechargeable battery pack

This long-life battery pack must be recharged when it fails to produce sufficient power on jobs which were easily done before. At the end of its technical life, discard it with due care for our environment:

- Run the battery pack down completely, then remove it from the tool.*
- Lithium-ion cells are recyclable. Take them to your dealer or a local recycling station. The collected battery packs will be recycled or disposed of properly.*

THE SYMBOLS IN INSTRUCTION MANUAL

	Double insulated for additional protection
	Read the instruction manual before using.
	CE conformity.
	Safety alert. Please only use the accessories supported by the manufacturer.
	Wear safety glasses, hearing protection and dust mask.
	Waste electrical products should not be disposed of with household waste. Please recycle where facilities exist. Check with your Local Authority or retailer for recycling advice.
	Charging the battery only below 40°C
	Always recycle batteries.
	Do not destroy battery by fire.
	Do not expose battery to water

ADDITIONAL SAFETY WARNING

Cordless rotary hammer safety warnings

1. Wear ear protectors. Exposure to noise can cause hearing loss.
2. Use auxiliary handle(s), if supplied with the tool. Loss of control can cause personal injury.
3. Hold power tool by insulated gripping surfaces, when performing an operation where the cutting accessory may contact hidden wiring. Cutting accessory contacting a "live" wire may make exposed metal parts of the power tool "live" and could give the operator an electric shock.
4. Wear a hard hat (safety helmet), safety glasses and/or face shield. Ordinary eye or sun glasses are NOT safety glasses. It is also highly recommended that you wear a dust mask and thickly padded gloves.
5. Be sure the bit is secured in place before operation.
6. Under normal operation, the tool is designed to produce vibration. The screws can come loose easily, causing a breakdown or accident. Check tightness of screws carefully before operation.
7. In cold weather or when the tool has not been used for a long time, let the tool warm up for a while by operating it under no load. This will loosen up the lubrication. Without proper warm-up, hammering operation is difficult.
8. Always be sure you have a firm footing. Be sure no one is below when using the tool in high locations.
9. Hold the tool firmly with both hands.
10. Keep hands away from moving parts.
11. Do not leave the tool running. Operate the tool only when hand-held.
12. Do not point the tool at any one in the area when operating. The bit could fly out and injure someone seriously.
13. Do not touch the bit or parts close to the bit immediately after operation; they may be extremely hot and could burn your skin.
14. Some material contains chemicals which may be toxic. Take caution to prevent dust inhalation and skin contact. Follow material supplier safety data.

INTENDED USE

The machine is intended for hammer drilling and chiseling in concrete, brick. It is also suitable for drilling without impact in wood, metal, ceramic and plastic.

SPECIFICATIONS

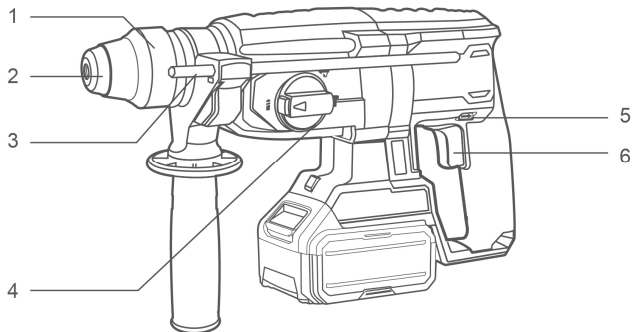

- | | |
|-------------------------------|---|
| 1. Tool holder locking sleeve | 4. Function mode selection switch |
| 2. Dust protection cap | 5. Forward and reverse rotation control |
| 3. Depth gauge | 6. On/off switch |

Technical specifications

Model No.		TRHLI2022875	UTRHLI2022875
		TRHLI20228xy	UTRHLI20228xy
Rated voltage		20V	20V
No load speed		0-1100r/min	0-1100r/min
Impact rate		0-5000/min	0-5000/min
Impact energy		2.5 J	2.5 J
Max. drilling capacity	Steel	13 mm	1/2 "
	Wood	30 mm	1-3/16 "
	Concrete	26 mm	1 "

Model No. Note: x (blank, 1,2,3,4,5,6,7,8,9,E,S,A,M); y (blank, -1,-2,-3,-4,-5,-6,-7,-8,-9,E,S,A,M)

- Due to our continuing program of research and development, the specifications herein are subject to change without notice.

⚠ WARNING!

Only use original battery pack and battery charger as below for this power tool:

Product	Battery pack		
Model No.	Type	Rated voltage	Rated capacity
TFBLI2001 TFBLI2001xy	Lithium-Ion	18.5V d.c., 20V Max	2.0Ah
TFBLI2002 TFBLI2002xy			4.0Ah
TFBLI2053 TFBLI2053xy			5.0Ah

Model No. NOTE: x (blank, 1,2,3,4,5,6,7,8,9,E,S,A,M); y (blank, -1,-2,-3,-4,-5,-6,-7,-8,-9,E,S,A,M)

Product	Battery pack charger			
Model No.	Input power	Input voltage	Output rated voltage	Output rated current
TFCLI2001 TFCLI2001xy	50W	220-240V ~50/60Hz	20V d.c.	2A
UTFCLI2001 UTFCLI2001xy		110-120V ~50/60Hz		
TFCLI20411 TFCLI20411xy TFCLI2034 TFCLI2034xy	105W	220-240V ~50/60Hz	21V d.c.	4A
UTFCLI20411 UTFCLI20411xy UTFCLI2034 UTFCLI2034xy		110-120V ~50/60Hz		

Model No. NOTE: x (blank, 1,2,3,4,5,6,7,8,9,E,S,A,M); y (blank, -1,-2,-3,-4,-5,-6,-7,-8,-9,E,S,A,M)

OPERATION PICTURE

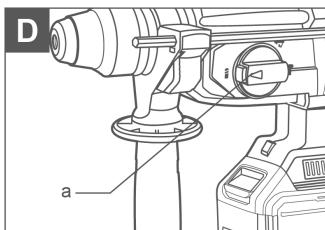
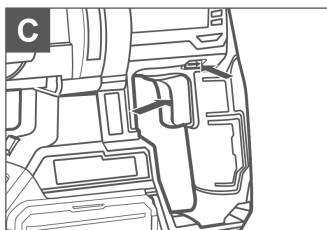
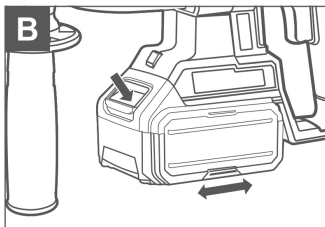
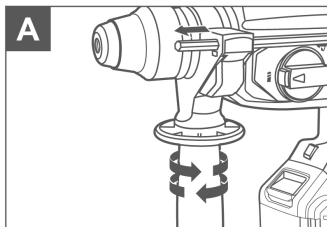

FUNCTION DESCRIPTION

Operation guidelines

⚠ NOTE: Before using the tool, read the instruction book carefully.

Before putting into operation

1. Charging the battery pack

The battery pack charger supplied is matched to the Li-ion battery installed in the machine. Do not use another battery charger. The Li-ion battery pack is protected against deep discharging. When the battery pack is empty, the machine is switched off by means of a protective circuit: The chuck no longer rotates. In a warm environment or after heavy use, the battery pack may become too hot to permit charging. Allow time for the battery pack to cool down before recharging. When the battery pack is charged for the first time and after prolonged storage. The battery pack will accept a 100% charge after several charge and discharge cycles.

2. To remove or install battery pack (see Figure A)

Depress the battery pack release button to release and slide the battery pack out from your tool. After recharge, slide it back into your tool. A simple push and slight pressure will be sufficient

OPERATION

1. Inserting and removing drill bit in SDS take care that the dust protection cap (2) is not damaged when changing tools.

Inserting

Clean and lightly oil the bit before inserting. Insert the dust-free bit into the bit holder with a twisting motion until it latches.

The bit locks itself. Check the locking by pulling on the tool.

Removing

Retract back the bit holder locking sleeve (3) and pull out the bit.

⚠ WARNING

Your new Rotary Hammer Drill generates powerful forces to get your job done quickly and effectively. These forces may cause inferior quality SDS bits to break and jam in the chuck, we therefore recommend that only high quality SDS bits be used with this tool.

2. Auxiliary handle (see Figure B)

Slide the handle onto the hammer and rotate to the desired working position. To clamp the auxiliary handle rotates the handle clockwise. To loosen the auxiliary handle, rotate the handle counter-clockwise.

WARNING

Always use the auxiliary handle.

3. Adjustable depth gauge (see Figure B)

Loosen the depth gauge by rotating the handle counter-clockwise. Slide the depth gauge until the distance between the depth gauge end and the drill bit end is equal to the depth of hole/screw you wish to make. Then clamp the depth gauge by rotating the handle clockwise.

4. On/off switch (see Figure C)

Depress the On/Off switch (5) to start and release it to stop your tool.

- On/off switch with variable speed control.

Depress the On/Off switch to start and release it to stop your tool. This tool has a variable speed switch (5) that delivers higher speeds with increased trigger pressure or delivers lower speeds with reduced trigger pressure - speed is controlled by varying the pressure applied to the switch.

5. Switch lock (see Figure C)

The switch trigger can be locked in the OFF position. This helps to reduce the possibility of accidental starting when not in use. To lock the switch trigger, place the direction of rotation control (6) in the center position.

6. Forward and reverse rotation control (see Figure C)

Forward rotation: Push the forward and reverse rotation control to the left "", for drilling.

Reverse rotation: Push the forward and reverse rotation control to the right "", for removing the drill bits.

WARNING

Never change the direction of rotation while the tool is rotating, wait until it has stopped.

7. Function mode selection (see Figure D)

The operation of the gearbox for each application is set with the function selector Figure I (4). To change between functions, depress the unlocking button (a) and rotate the selector to the desired operating mode.



Mode for simultaneous drilling and impacting of concrete, Masonry



Mode for or drilling into steel, wood and plastics



Mode for or chiseling



Mode for adjust the chuck angle of chiseling

△ NOTE: Select this function mode first, adjust the chuck angle to desired direction. Then select the function mode to "  ", operate the chiseling work.

△ WARNING: The operating mode selector switch may be actuated only at a standstill.

8. Overload protection

When overloaded, the motor comes to a stop. Relieve the load on the machine immediately and allow cooling for approx. 30 seconds at the highest no-load speed.

9. Temperature dependent overload protection

When using as intended for, the power tool cannot be subject to overload. When the load is too high or the allowable battery temperature of 75 °C is exceeded, the electronic control switches off the power tool until the temperature is in the optimum temperature range again.

10. Protection against deep discharging

The Li-ion battery is protected against deep discharging by the "Discharging Protection System". When the battery is empty, the machine is switched off by means of a protective circuit: The inserted tool no longer rotates.

Working hints for your tool

If your power tool becomes over heated, set the speed to maximum and run no load for 2-3 minutes to cool the motor. SDS-plus tungsten carbide drill bits should always be used for concrete and masonry.

When drilling in metal, only use HSS drill bits in good condition. Where possible use a pilot hole before drilling a large diameter hole.

Problem solution

1.Reasons for different charging times

Your charge time can be affected by many reasons which are not defects in your product. If the battery pack is only partly discharged it may be re-charged in less than 1 hour. If the battery pack and ambient temperature are very cold then re-charging may take 1-1.5 hours. If the battery pack is very hot it will not re-charge because the internal temperature safety cutout will prevent it. If the battery pack is very hot you must remove your battery pack from the charger and allow your battery pack to cool first to ambient temperature and then recharging can be started. If you charge a second battery pack immediately after the first then the charger can be overheated. Always allow at least 15 minutes rest between battery pack charging.

2.Reasons for different battery pack working times

Charging time problems, having not used a battery pack for a prolonged time will reduce the battery pack working time. This can be corrected after several charge and discharge operations by charging & working with your drill. Heavy working conditions such as large screws into hard wood will use up the battery pack energy faster than lighter working conditions. Do not re-charge your battery pack below 0°C and above 30°C as this will affect performance.

Maintenance

Remove the battery pack from the tool before carrying out any adjustment, servicing or maintenance.

Your power tool requires no additional lubrication or maintenance. There are no user serviceable parts in your power tool. Never use water or chemical cleaners to clean your power tool. Wipe clean with a dry cloth. Always store your power tool in a dry place. Keep the motor ventilation slots clean. Keep all working controls free of dust. Occasionally you may see sparks through the ventilation slots. This is normal and will not damage your power tool.

Environmental protection



Disposal

The machine, its accessories and packaging materials should be sorted for environmentally friendly recycling. The plastic components are labeled for categorized recycling.

MAINTENANCE&MALFUNCTIONS

Possible malfunctions and methods of their eliminations

Malfunction	Probable causes	Actions
When the machine is turned on, the electric motor does not work.	<ul style="list-style-type: none"> ● Switch failure ● The power cord or wiring is broken, power cord plug malfunction; ● No brush contact with the collector; ● Wear/damage of brushes 	Disconnect the machine from the mains and contact a qualified specialist.
Formation of a circular fire on the collector	<ul style="list-style-type: none"> ● Brush wear/damage of the brush holder; ● Malfunction in the armature coil 	Disconnect the machine from the mains and contact a qualified specialist. Please don't repair the machine by your own.
When working, smoke or the smell of burning insulation appears from the ventilation openings.	<ul style="list-style-type: none"> ● Malfunction in the electric motor coil; ● Malfunction of the electrical part of the tool. 	
Increased noise in the gearbox	<ul style="list-style-type: none"> ● Wear/breakage of gears or bearings 	
When the machine is turned on, the spindle does not rotate	<ul style="list-style-type: none"> ● Gearbox failure. 	

Critical state criteria

Critical state criteria	Probable causes	Actions
Cracks on the surfaces of bearing and housing parts	Fatigue deformation of metal	Disconnect the machine from the mains and contact a qualified specialist. Please don't repair the machine by your own.
The power cord or plug is damaged	Overload or breakage	
Excessive wear or damage to the motor or reductor mechanism, or a combination of signs	Fatigue deformation of metal	

Critical state criteria

List of critical failures	Actions
Electric motor sparking	It is necessary to contact a qualified specialist
The appearance of extraneous noise	It is necessary to contact a qualified specialist
If the above malfunctions are detected, it is necessary to disconnect the machine from the mains and contact a qualified specialist	

TOTAL

One-Stop Tools Station

www.totalbusiness.com



MADE IN CHINA T0224.V01



NEWWAY TECHNOLOGY (SUZHOU) CO., LIMITED
No. 20 Dagang Road, Fuqiao Town, Taicang City, China

